

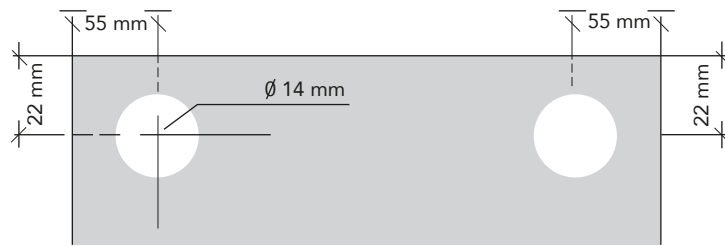

















FURAÇÃO VIDRO PADRÃO

PORTA
Máx. 1200mm - 70kg
VIDRO
Temperado 10/8mm
VÃO
Máx. 900mm

FOLGA ESPECIAL
 Para projetos acima de 2 metros considerar **40mm** na folga.

COMPONENTES FORNECIDOS

IDENT.	PEÇA	QUANT.	DESCRIÇÃO
A		01	Barra Superior
B			
C		02	Suporte Metal E
D		02	Freio Superior
E		02	Roldana Box
F		01	Puxador Porta
G		01	Chave Allen
H		01	Perfil Guia
I		02	Perfil "U" 20x11x8,7
J		02	Cunha Regulagem
K		01	Click
L		02	Silicone Sólido
M		02	Batedeira Inferior
N		04	Parafuso
O		04	Bucha 6mm
P		02	Guia Nylon
Q		02	Acabamento "U"
R		02	Acabamento Trilho
S		02	Tapa furo suportes

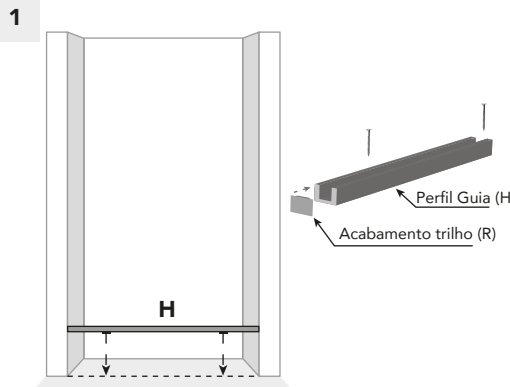

- Confira as medidas dos vidros, do vão e nível do chão.
- Corte o Perfil Inferior (H), 3mm menor que a medida do vão, faça 3 furos para fixação e 3 furos para escoamento de água. Parafuse e vede com silicone no local.
- Coloque os terminais de acabamento e o batedor inferior.

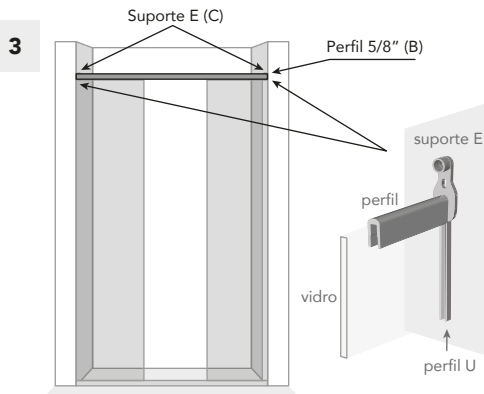

- Corte a barra superior 20mm menor que o vão
- Encaixe o trilho superior sobre os vidros fixos
- Então encaixe o suporte E e parafuse os dois parafusos. Coloque o tampa furo no para parafuso inferior para acabamento

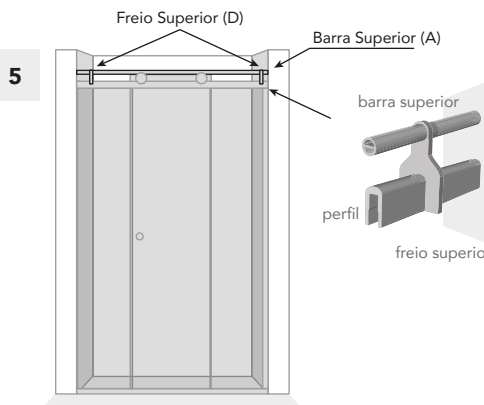

- Encaixe o freio na barra de segurança (A) após cortá-la 20mm menor que o vão
- Com cuidado, coloque na posição desejada na barra superior e encaixe o lado do vidro fixo no suporte E
- Finalize com o perfil "U" para recebimento da porta. Encaixe os click's de acabamento por último.

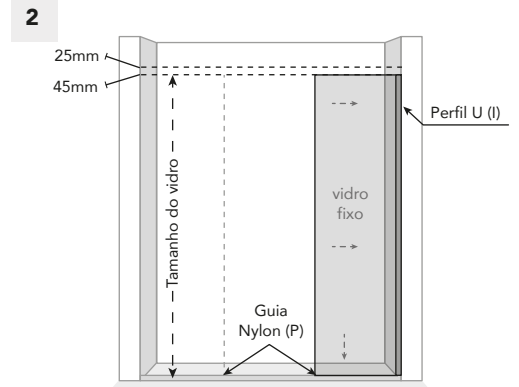

- Corte o perfil U 20x11x8,7 (I) na medida do vidro fixo
- Fixe os perfis e encaixe os vidros fixos no perfil inferior e nos laterais
- Encaixe a guia nylon (P) no perfil inferior junto ao vidro fixo

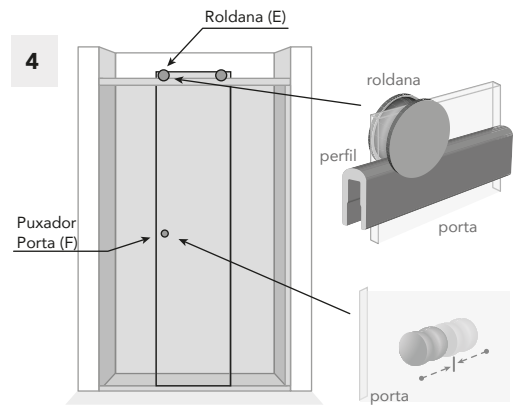

- Encaixe as roldanas (E) na porta e o puxador (F)
- Após instalados, com cuidado apoie sobre o perfil superior. As roldanas são exêntricas, para regulagem com a parede. Após reguladas, aperte bem para travá-las.

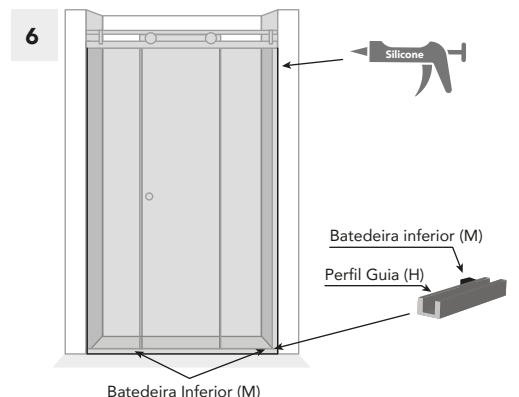

- Encaixe e fixe as batedeiras inferiores para orientar a abertura e o fechamento da porta
- Finalize aplicando o silicone nas laterais junto ao perfil U e na base junto ao perfil Guia.
- Espere 24h antes de usar.